

Sources of Energy

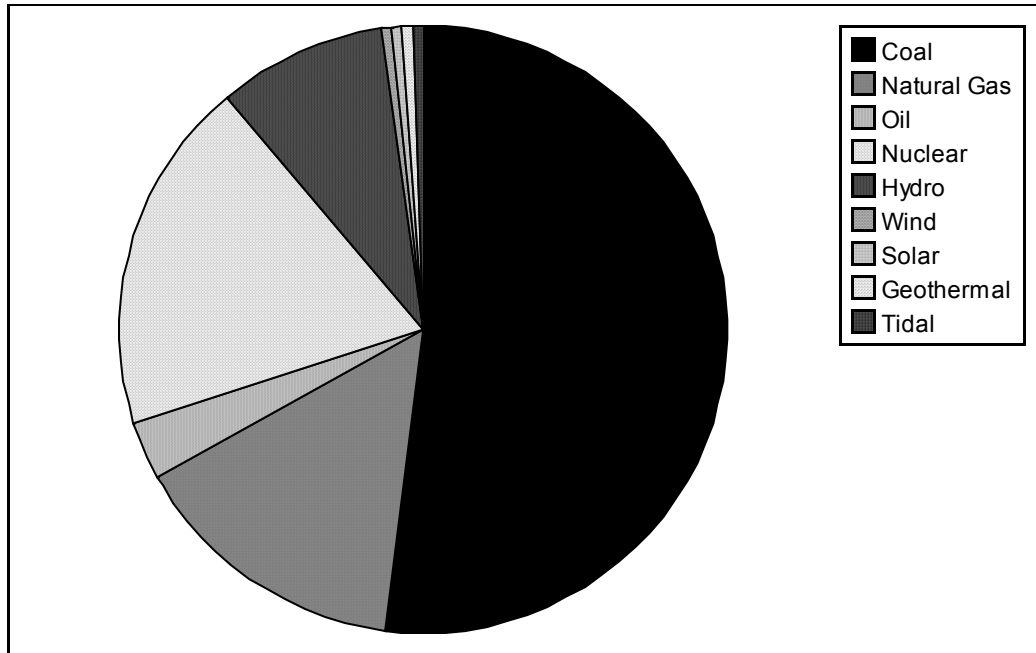

Fossil Fuels	70%
• Coal	52%
• Natural Gas	15%
• Oil	3%
Nuclear	19%
Hydro	9%
Wind	0.5%
Solar	0.5%
Geothermal	0.5%
Tidal	0.5%

Sources of Energy Comparison

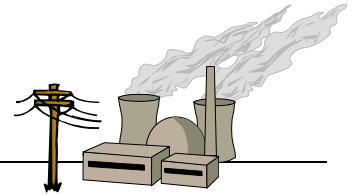
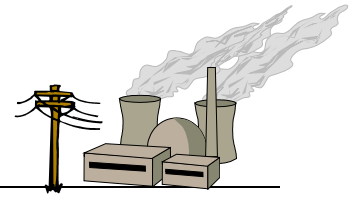

Solar

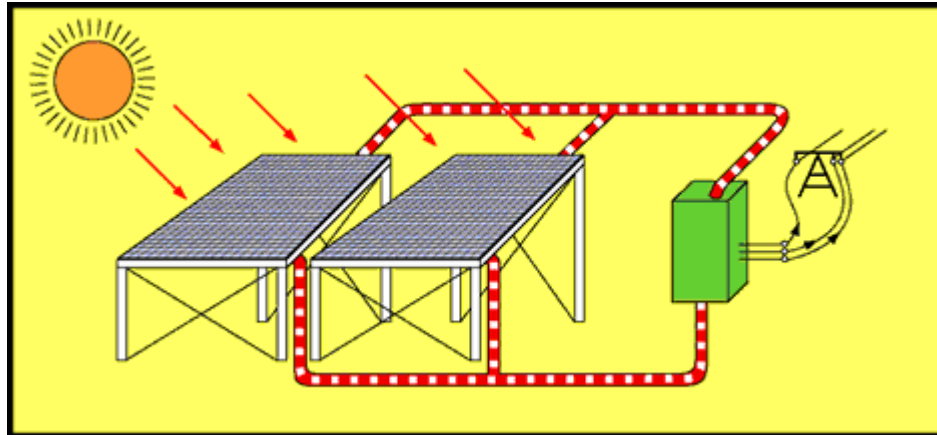

Geothermal

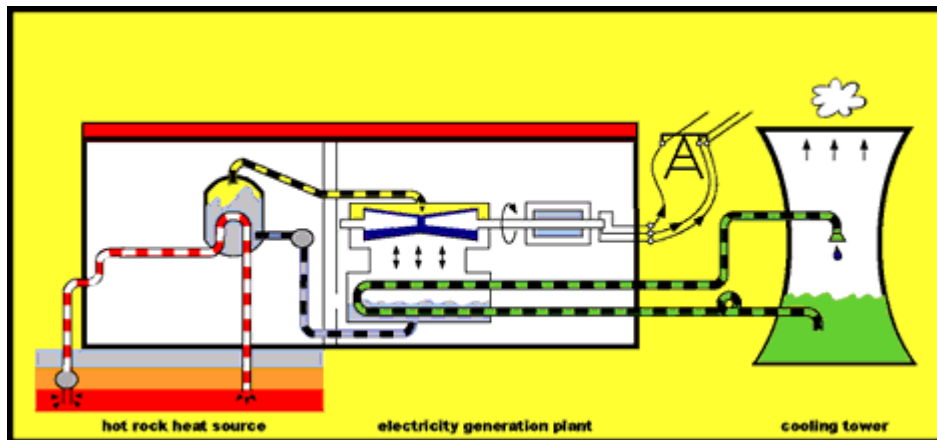

Biomass

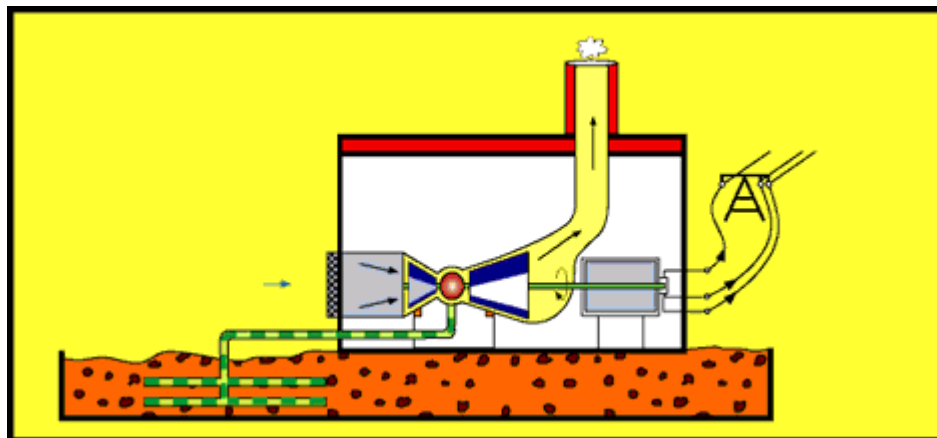

Hydro

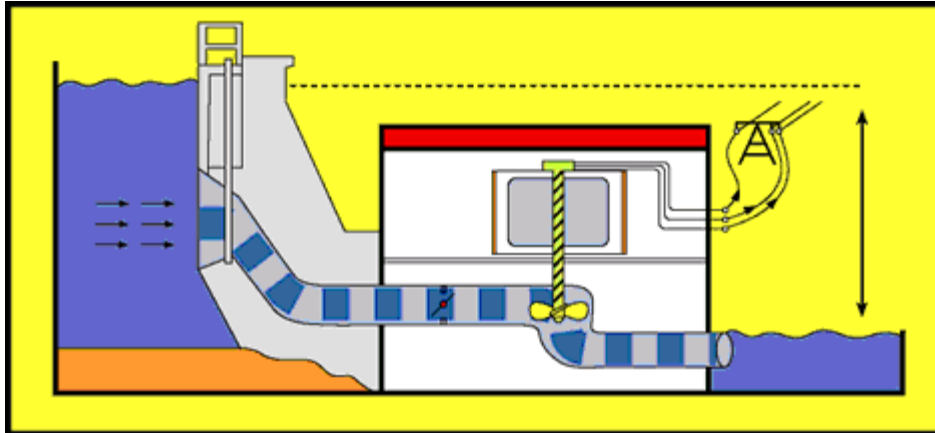

Waves

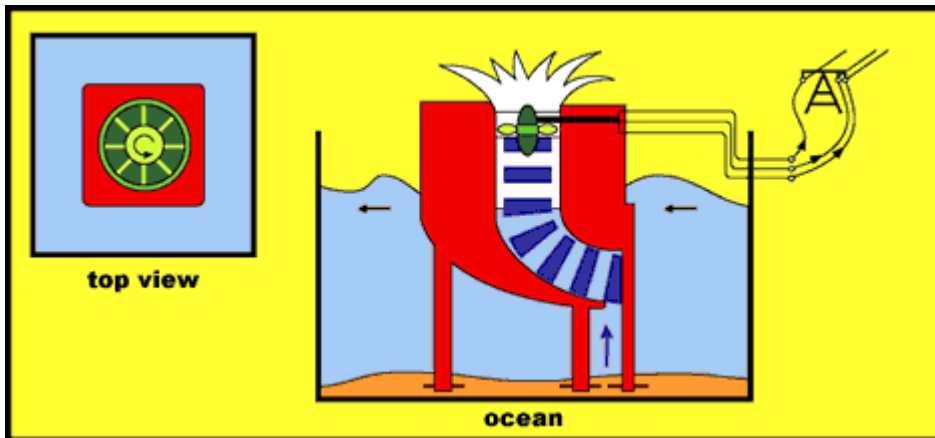

Tides

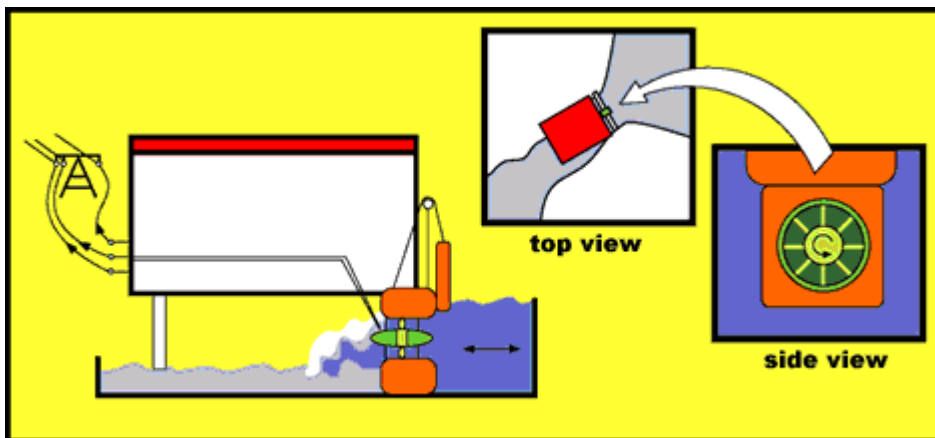

Wind

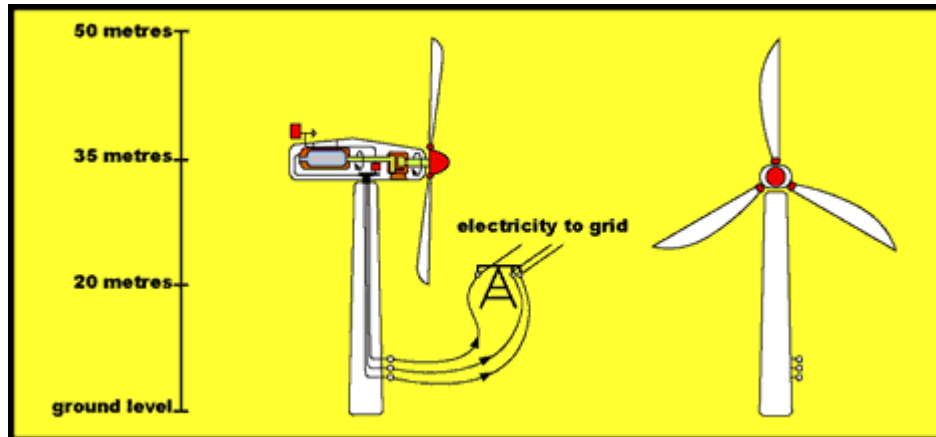

Nuclear

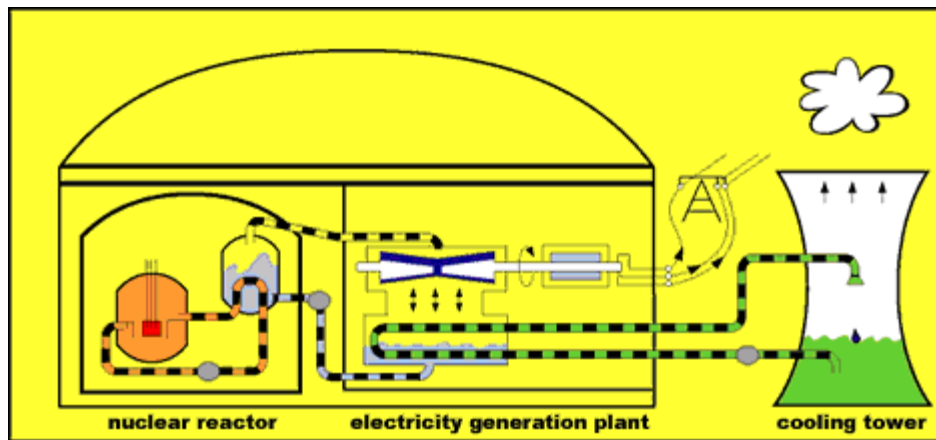

Fossil Fuels

