

# Sources of Energy Comparison

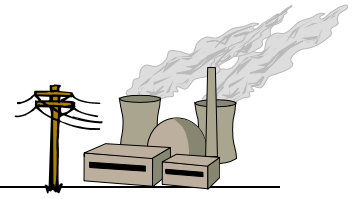

## Solar

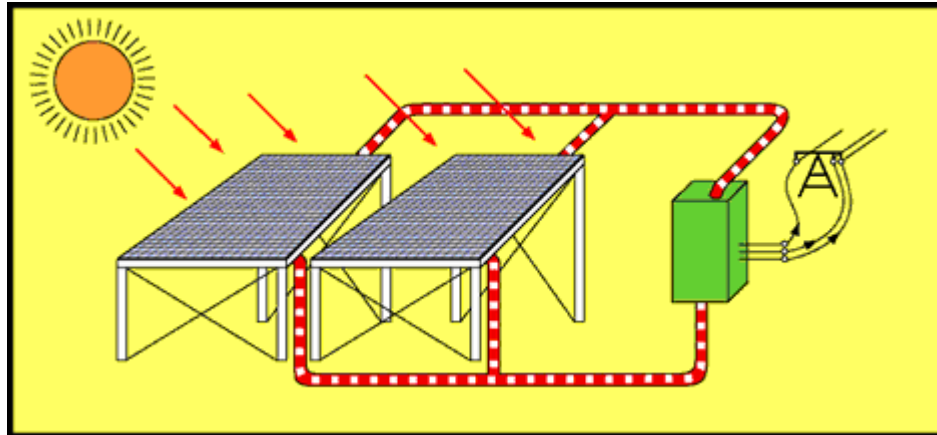

## Geothermal

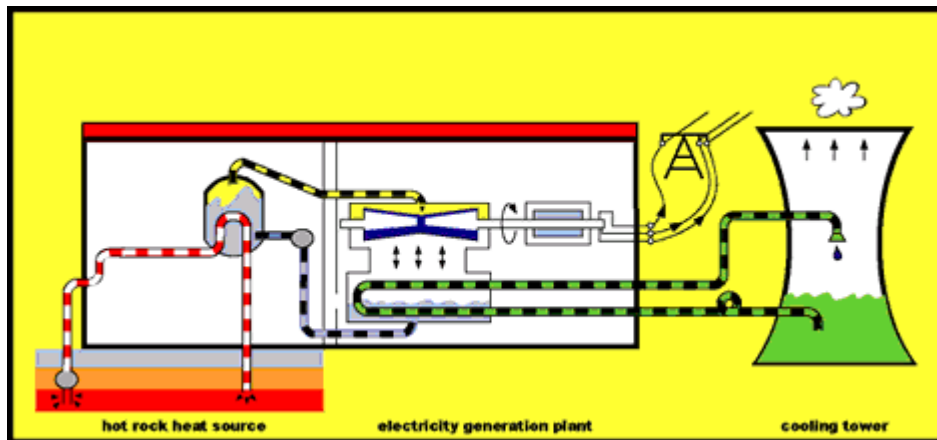

## Biomass

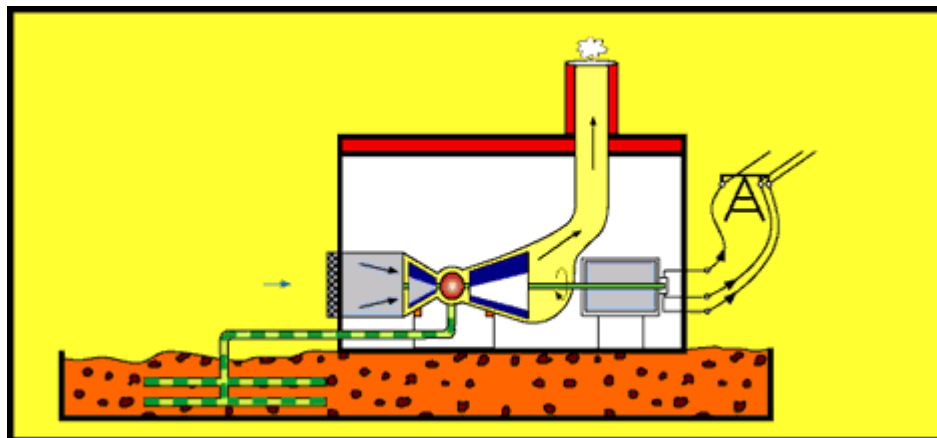

## Hydro

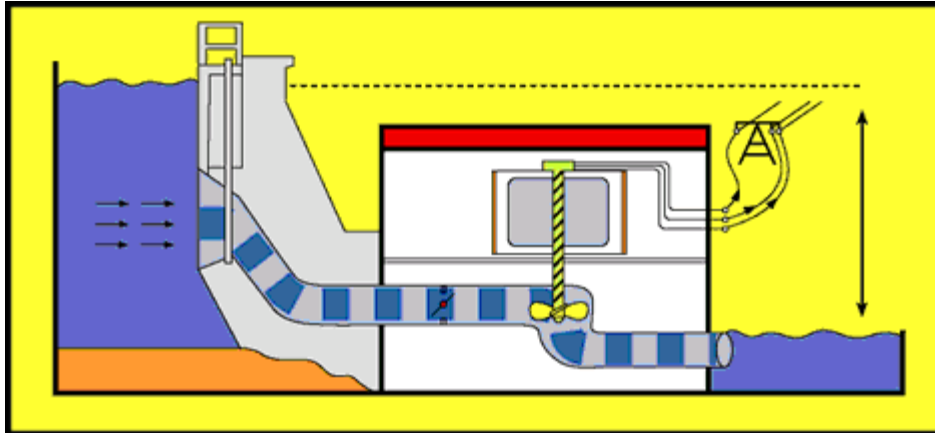

## Waves

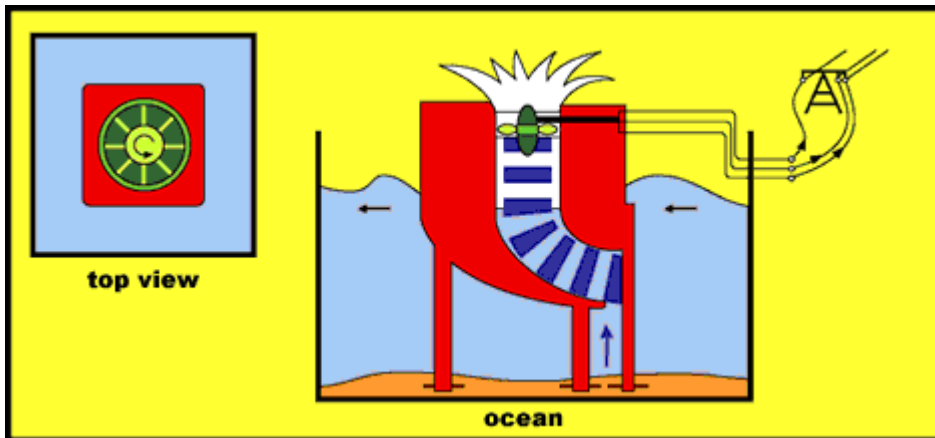

## Tides

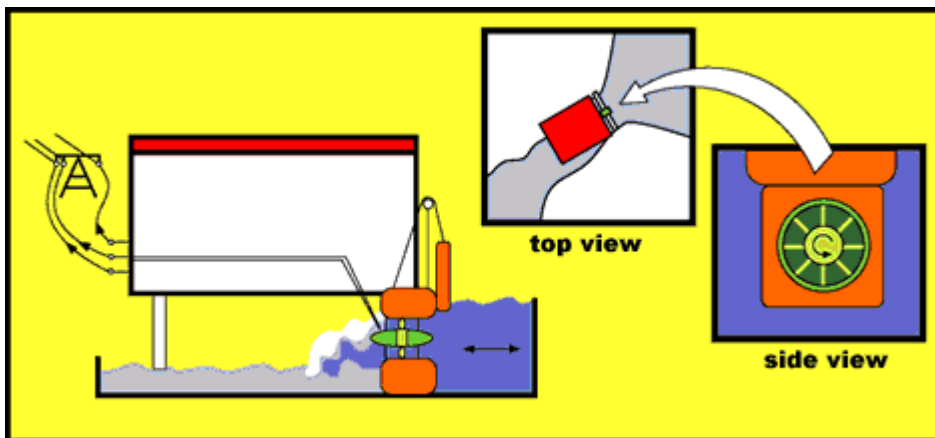

## Wind

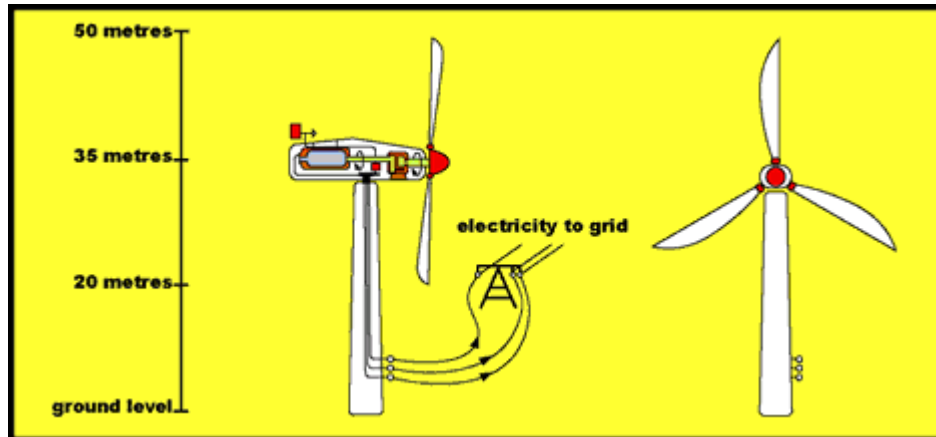

## Nuclear

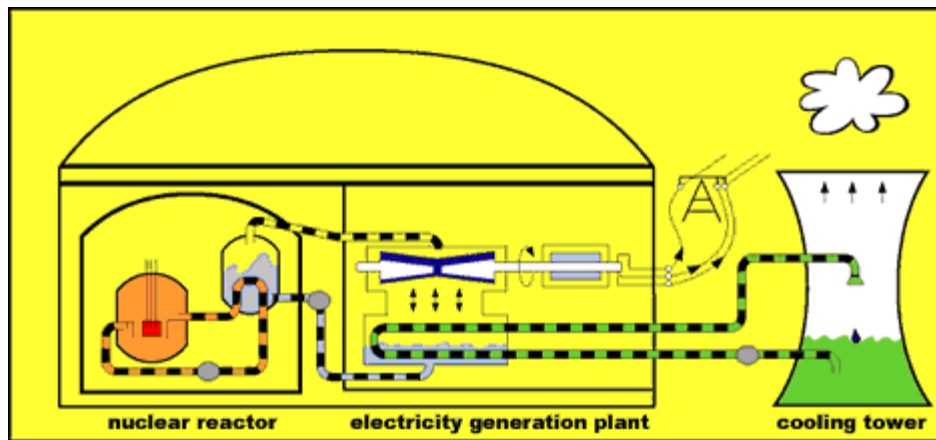

## Fossil Fuels

